

Displays & Touch Screens

ULTRATRONIK Vertriebs GmbH

Dornierstraße 9
82205 Gilching

T +49 8105 77839-0
F +49 8105 77839-850

www.ultratronic-distribution.de
displays@ultratronic.de

Error and omissions excepted
Observe notice of protected rights in accordance to DIN34 / ISO16016





DATA IMAGE CORPORATION

CTP Module Specification

Preliminary

ITEM NO.: SCX1001255GGU20

Table of Contents

1. COVER & CONTENTS	1
2. RECORD OF REVISION	2
3. GENERAL SPECIFICATIONS	3
4. ABSOLUTE MAXIMUM RATINGS	3
5. ELECTRICAL CHARACTERISTICS	3
6. PIXEL FORMAT IMAGE	4
7. INPUT SIGNAL CHARACTERISTICS	5
8. OPTICAL CHARACTERISTIC	7
9. BLOCK DIAGRAM	9
10. PIN CONNECTIONS	10
11. CTP SPECIFICATIONS.....	13
12. QUALITY ASSURANCE	14
13. LCM PRODUCT LABEL DEFINE.....	18
14. PRECAUTIONS IN USE LCM	20
15. OUTLINE DRAWING	21
16. PACKAGE INFORMATION.....	22

Customer Companies	QA Approval	QA Check	R&D Approval	R&D Check
	<i>pretty</i>	<i>Yuan Juan</i>	<i>Gromer</i>	<i>Max</i>
Approved by	Version:	Issued Date:	Sheet Code:	Total Pages:
	2	06/Sep/17'		22

3. GENERAL SPECIFICATIONS

Parameter	Specifications	Unit
Screen Size	10.1 (diagonal)	inch
Display Format	1280(H) x (R,G,B) x 800(V)	dot
LCD Active Area	216.96(W) ×135.6 (H)	mm
Sensor active area	218.96(W) ×137.6(H)	
Pixel Pitch	0.1695(W) × 0.1695(H)	mm
Pixel Configuration	RGB-Stripe	
Outline Dimension	257.5(W) ×180(H) ×13.15(D)	mm
Back-light	LED	
LCM Interface	LVDS	
View direction	ALL	
LCM model number	FX1001P1DSSWMGL1	
Weight	TBD	g
Our components and processes are compliant to RoHS standard		

4. ABSOLUTE MAXIMUM RATINGS

(Note 1)

Parameter	Symbol	MIN.	MAX.	Unit	Remark
Power voltage	V _{DD}	-0.3	5	V	
Operating temperature	T _{OP}	-20	70	°C	
Storage temperature	T _{ST}	-30	80	°C	

Note 1: The absolute maximum rating values of this product are not allowed to be exceeded at any times. Should a module be used with any of the absolute maximum ratings exceeded, the characteristics of the module may not be recovered, or in an extreme case, the module may be permanently destroyed.

5. ELECTRICAL CHARACTERISTICS

5.1 Typical Operation Conditions

Parameter	Symbol	MIN.	TYP.	MAX.	Unit	Remark
Power voltage	V _{DD}	2.5	3.3	3.6	V	Note 1
Power Supply Voltage for LED	V _{IN}	-	12	-	V	
Power Supply Current for LED	I _{VIN}	-	390	460	mA	
Input logic high voltage	V _{IH}	0.8V _{DD}	-	3.6	V	Note 1
Input logic low voltage	V _{IL}	0	-	0.2 V _{DD}	V	
Input signal Voltage	BLBRT	0.3	-	V _{IN}		
	BLEN	0.3	-	V _{IN}		

Note 1: V_{DD} setting should match the signals output voltage of customer's system board.

6. Pixel Format Image

Figure 3 shows the relationship of the input signals and LCD pixel format image

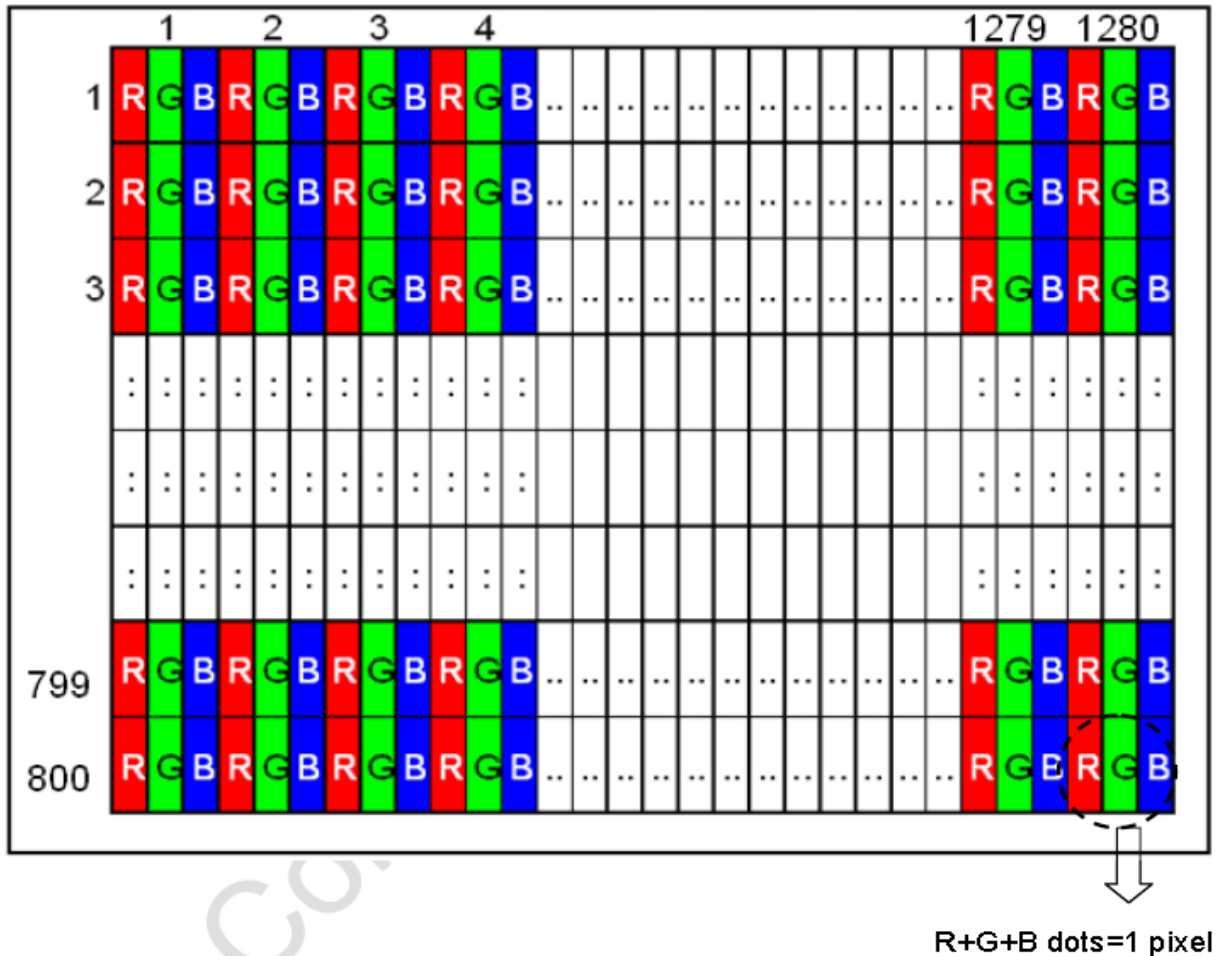

Figure 3 Pixel Format

7. INPUT SIGNAL CHARACTERISTICS

7.1 AC Characteristics

Parameter	Symbol	MIN.	TYP.	MAX.	Unit	Remark
Differential input high Threshold voltage	RxVTH	-	-	+100	mV	V _{CM} =1.2V
Differential input low Threshold voltage	RxVTL	-100	-	-	mV	
Common Mode Voltage	V _{CM}	0.3+(VID/2)	-	VDD-1.2-(VID/2)	v	
Common Mode Voltage	ΔV _{CM}	-	-	50	mV	V _{CM} =1.2V
Differential voltage	VID	200	-	400	mV	

Note : Input signals shall be low or Hi-Z state when VDD is off.

(2) All electrical characteristics for LVDS signal are defined and shall be measured at the interface connector of LCD.

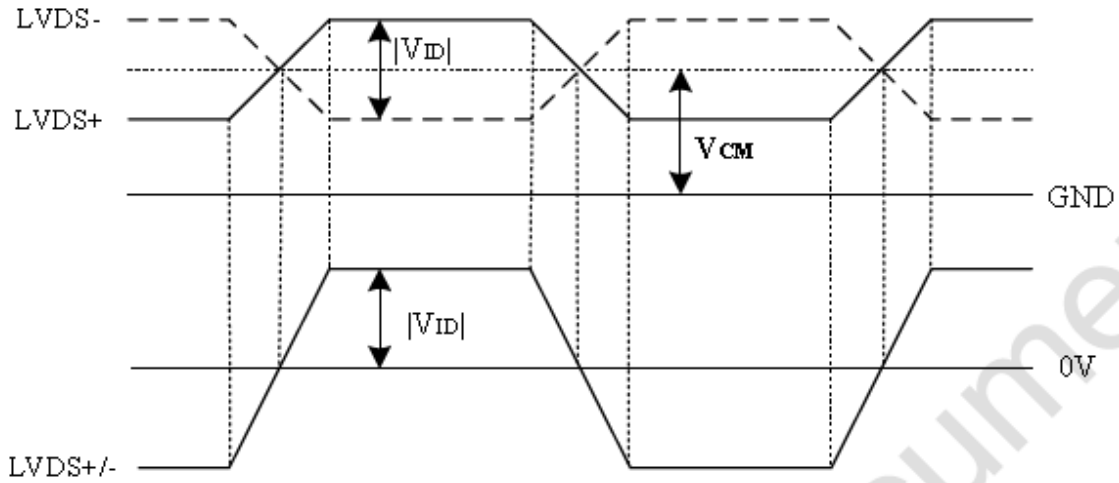
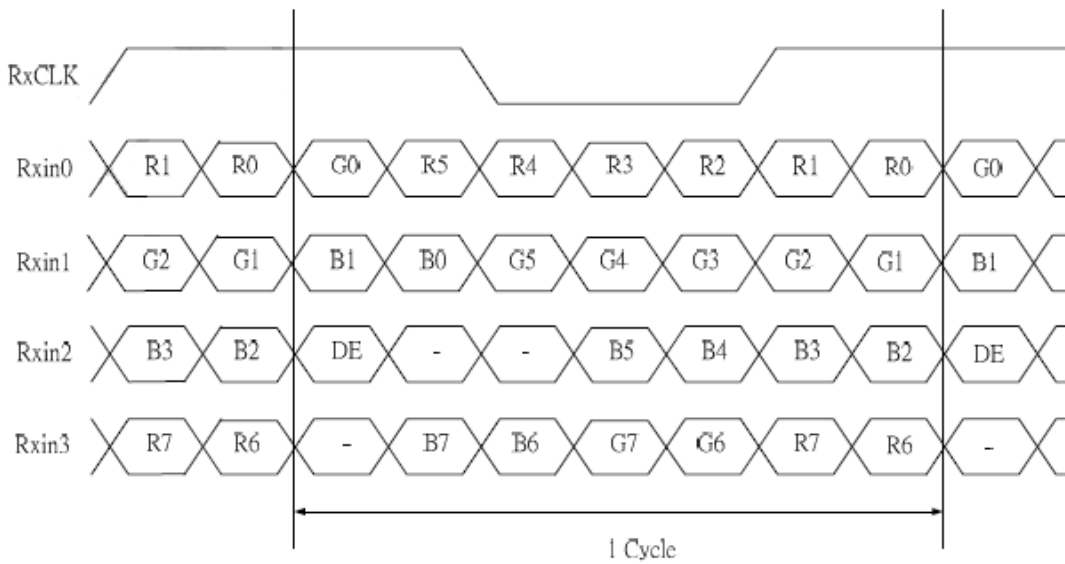
Voltage Definitions

LVDS Data Mapping

7.2 Interface Timings

Parameter	Symbol	MIN.	TYP.	MAX.	Unit	Remark
Frame Rate	-	-	60	-	Hz	
Frame Period	t_v	815	823	1023	line	
Vertical display area	t_{vd}	800			line	
Vertical Blanking Time	$t_{vw}+t_{vbp}+t_{vfp}$	15	23	33	line	
1 Line Scanning Time	t_H	1410	1440	1470	clock	
Horizontal Display Time	t_{HD}	1280			clock	
Horizontal Blanking Time	$t_{HW}+t_{HBP}+t_{HFP}$	60	160	190	clock	
Clock Rate	$1/T_C$	68.9	71.1	73.4	MHz	

7.3 Timing Diagram of Interface Signal (DE mode)

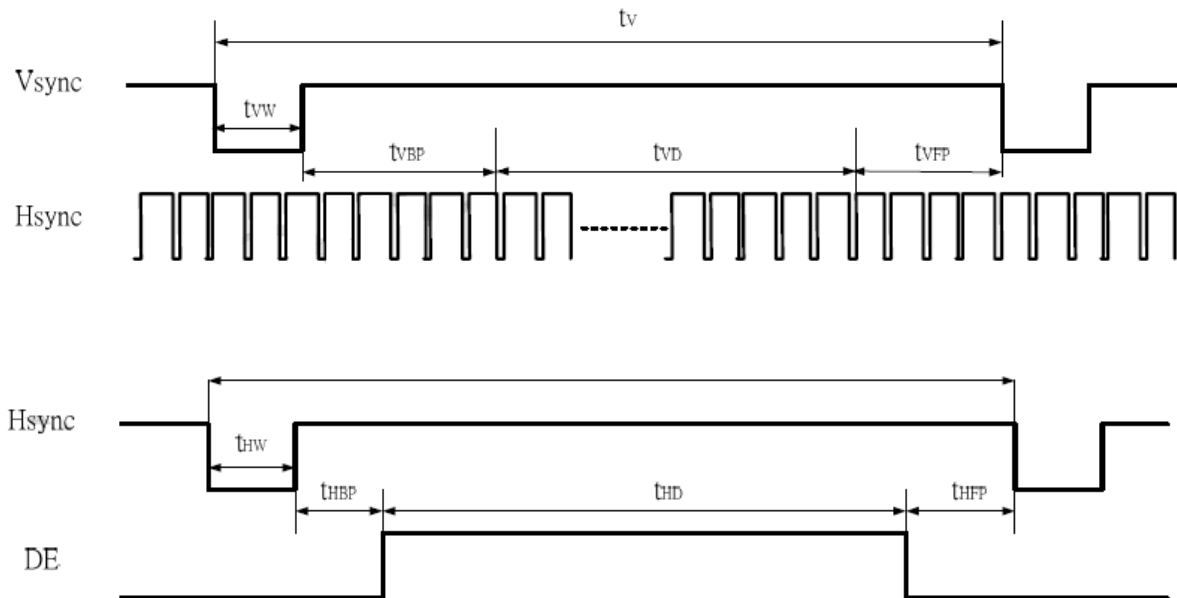
Timing Characteristics



8. OPTICAL CHARACTERISTIC

Parameter	Symbol	Condition	MIN.	TYP.	MAX.	Unit	Remarks			
Viewing Angle (CR≥10)	θ_L	$\Phi=180^\circ$ (9 o'clock)	75	85	-	deg	Note 1			
	θ_R	$\Phi=0^\circ$ (3 o'clock)	75	85	-					
	θ_T	$\Phi=90^\circ$ (12 o'clock)	75	85	-					
	θ_B	$\Phi=270^\circ$ (6 o'clock)	75	85	-					
Contrast Ratio	CR	Normal $\theta=\Phi=0^\circ$	600	800	-		Note 4			
Response time	Rising +Falling		-	25	50	ms	Note 3			
Color chromaticity	Rx		Normal $\theta=\Phi=0^\circ$	Typ. -0.05	0.561	Typ. +0.05	-	Note 2,5,6		
	Ry				0.334		-			
	Gx				0.341		-			
	Gy				0.568		-			
	Bx				0.161		-			
	By				0.129		-			
	Wx				Typ. -0.04		0.300		Typ. +0.04	-
	Wy				0.3615		-			
Luminance	L	340	420	-	cd/m ²	Note 6				
Color temperature	Tc	5270	-	10220	K	Only reference				
Luminance uniformity	Yu	70	75	-	%	Note 7				

Test Conditions:

- VDD=3.3V, LED_VCCS=12V (Backlight current), the ambient temperature is 25°C.
- The test systems refer to Note 2.

Note 1: Definition of viewing angle range

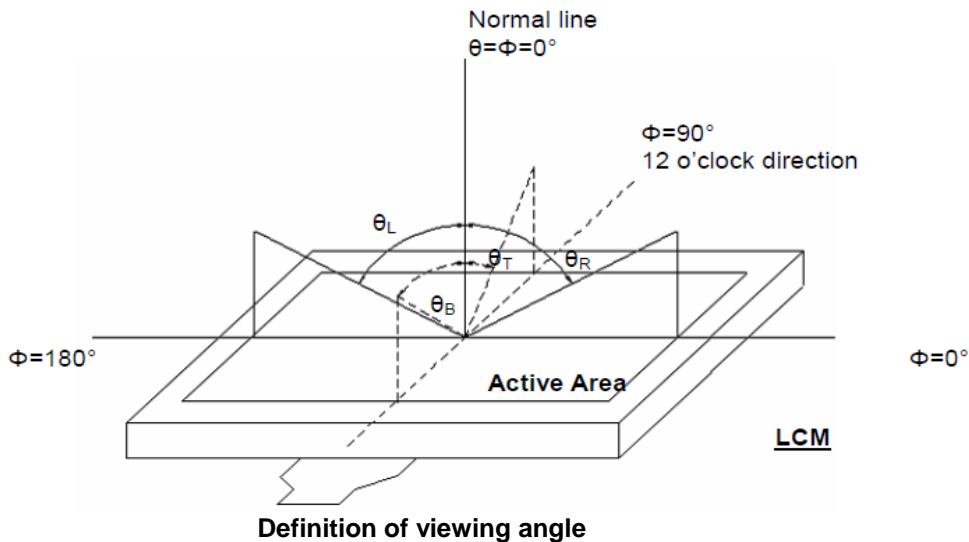

Note 2: Definition of optical measurement system.

The optical characteristics should be measured in dark room. After 30 minutes operation, the optical properties are measured at the center point of the LCD screen. (Viewing angle is measured by ELDIM-EZ contrast/Height : 1.2mm, Response time is measured by Photo detector TOPCON BM-7, other items are measured by BM-5A/ Field of view: 1° /Height: 500mm.)

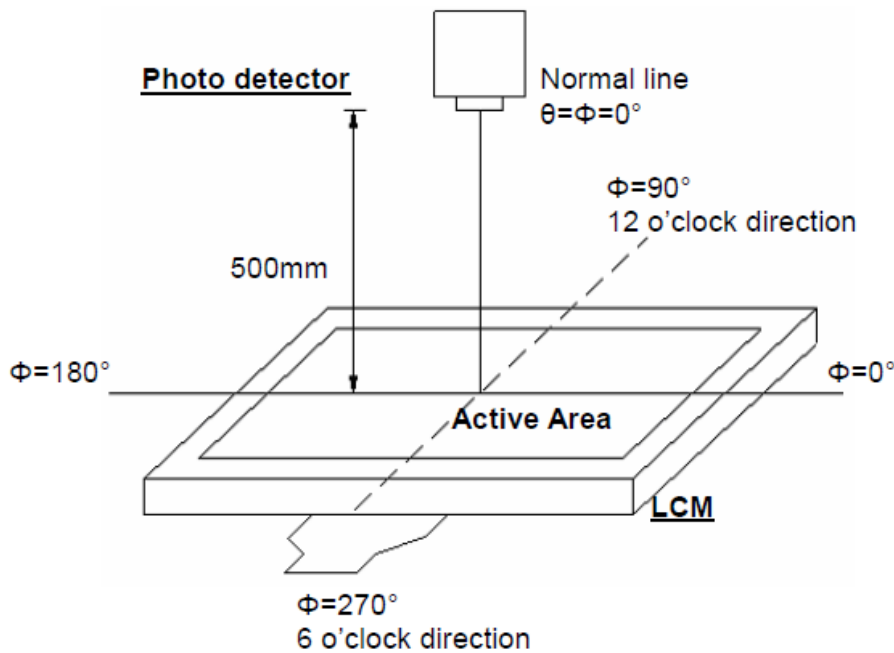

Optical measurement system setup

Note 3: Definition of Response time

The response time is defined as the LCD optical switching time interval between "White" state and "Black" state. Rise time (T_{ON}) is the time between photo detector output intensity changed from 90% to 10%. And fall time (T_{OFF}) is the time between photo detector output intensity changed from 10% to 90%.

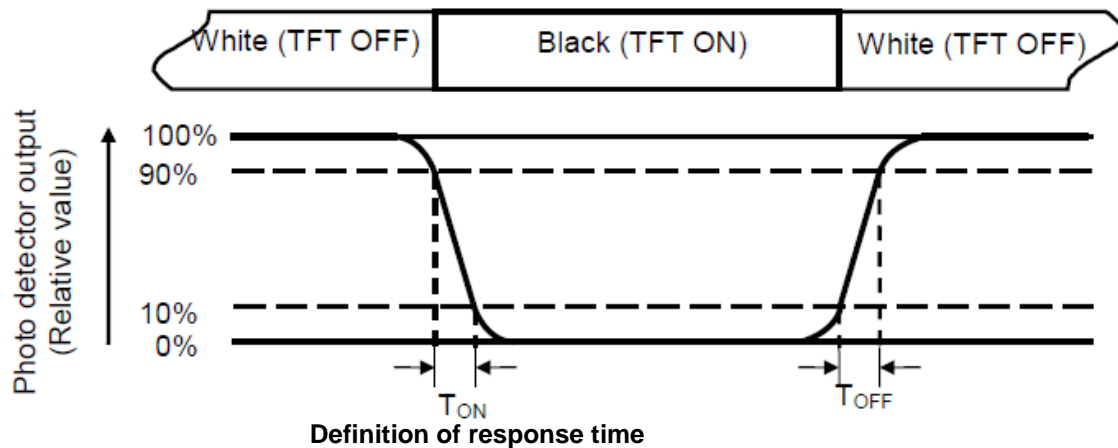

Note 4: Definition of contrast ratio

$$\text{Contrast ratio (CR)} = \frac{\text{Luminance measured when LCD on the "White" state}}{\text{Luminance measured when LCD on the "Black" state}}$$

Note 5: Definition of color chromaticity (CIE1931)
Color coordinates measured at center point of LCD.

Note 6: Measuring the center area of the panel. The LED driving condition is LED_VCCS=12V

Note 7: Definition of Luminance Uniformity

Active area is divided into 9 measuring areas. Every measuring point is placed at the center of each measuring area.

$$\text{Luminance Uniformity (Yu)} = \frac{B_{min}}{B_{max}}$$

L-----Active area length W----- Active area width

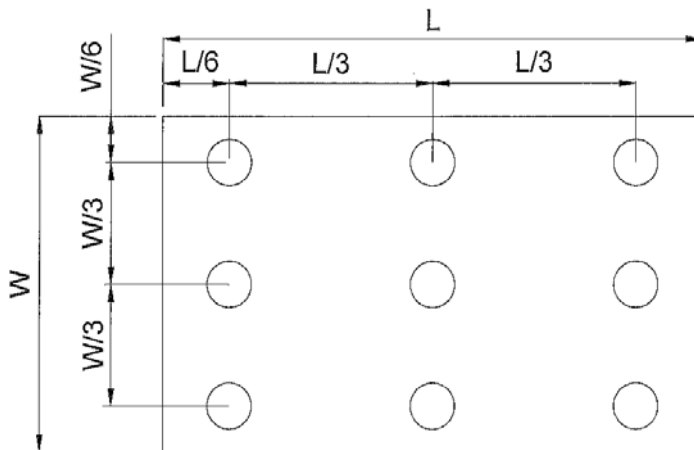

9. BLOCK DIAGRAM

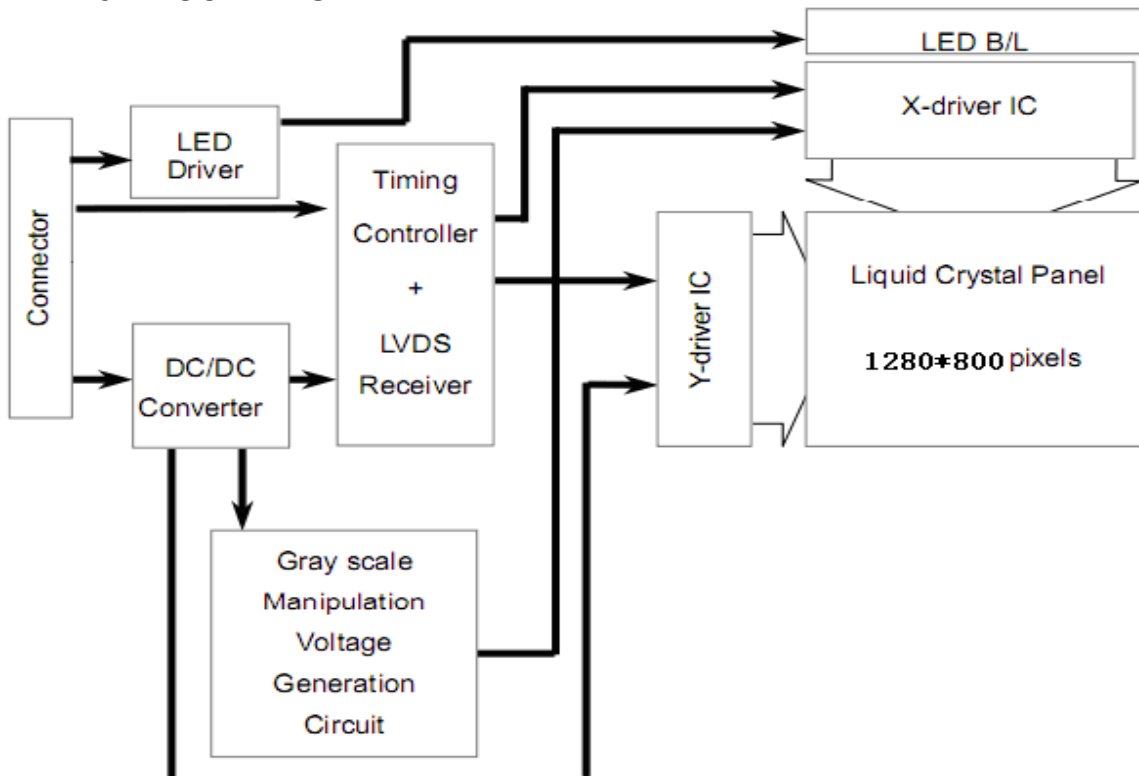

10. PIN CONNECTIONS

10.1 CN1 FUNCTIONS

Pin No	Symbol	Function
1	NC	No connection
2	BIST	BIST pin , auto testing pattern on/off control, low=off, high=on.
3	RXIN3+	LVDS receiver signal CH3(+)
4	RXIN3-	LVDS receiver signal CH3(-)
5	GND	Ground
6	CK IN+	LVDS receiver signal CK(+)
7	CK IN-	LVDS receiver signal CK(-)
8	GND	Ground
9	RXIN2+	LVDS receiver signal CH2(+)
10	RXIN2-	LVDS receiver signal CH2(-)
11	GND	Ground
12	RXIN1+	LVDS receiver signal CH1(+)
13	RXIN1-	LVDS receiver signal CH1(-)
14	GND	Ground
15	RXIN0+	LVDS receiver signal CH0(+)
16	RXIN0-	LVDS receiver signal CH0(-)
17	GND	Ground
18	NC	No connection
19	VDD	power supply
20	VDD	power supply

10.2 CN2 FUNCTIONS

Pin No	Symbol	Function
1	GND	Ground
2	BLBRT	PWM signal(Brightness adjustment)
3	BLLEN	ON/OFF terminal voltage
4	GND	Ground
5	VIN	+12V power supply
6	VIN	+12V power supply
7	VIN	+12V power supply
8	GND	Ground

PWM: The frequency must be in the range of 100Hz to 22 kHz

EN: High = IC is enabled; low = IC is disabled.

Note: LED_PWM is used to adjust backlight brightness.

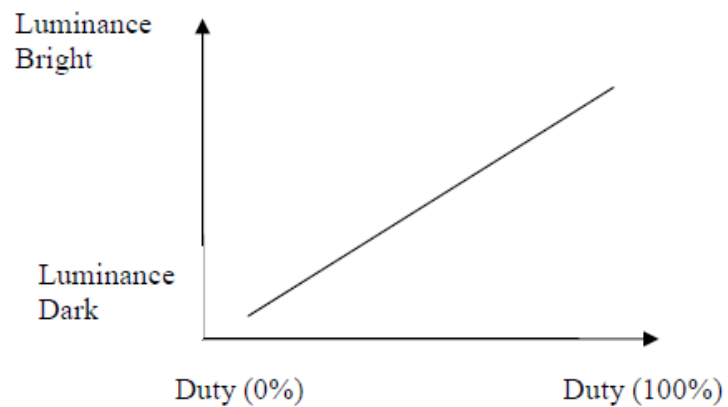

Power ON/OFF Sequence

Power on/off sequence is as follows. Interface signals are also shown in the chart. Signals from any system shall be Hi-Z state or low level when VDD is off.

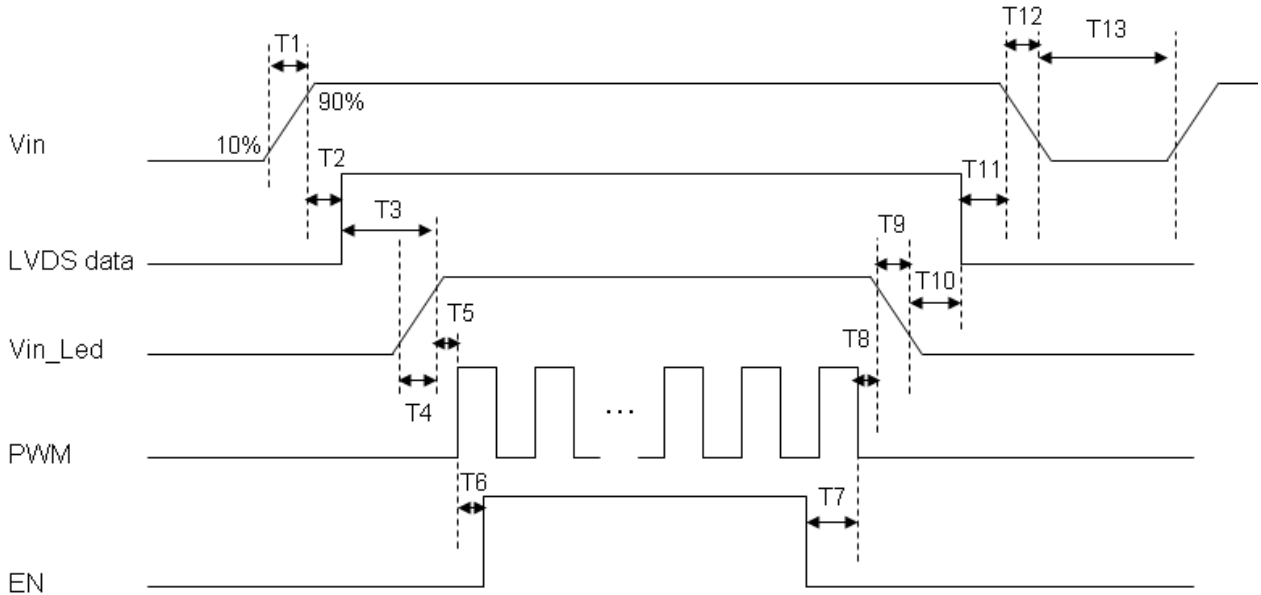

Figure 9-3 Power Sequence

10.3.1 Power Sequencing Requirements

Parameter	Symbol	min	Typ.	max	Unit
VIN Rise Time	T1	0.5	--	10	ms
VIN Good to Signal Valid	T2	30	--	90	ms
Signal Valid to Backlight On	T3	200	--	--	ms
Backlight Power on Time	T4	0.5	--	--	ms
Backlight VDD Good to System PWM on	T5	10	--	--	ms
System PWM on to Backlight Enable on	T6	10	--	--	ms
Backlight Enable off to System PWM off	T7	0	--	--	ms
System PWM off to B/L Power Disable	T8	10	--	--	ms
Backlight Power off Time	T9	0.5	10	30	
Backlight Off to Signal Disable	T10	200	--	--	ms
Signal Disable to Power Down	T11	0	--	50	ms
VIN Fall Time	T12	0.5	10	30	ms
Power Off	T13	500	--	--	ms

11. CTP SPECIFICATIONS

11.1 GENERAL SPECIFICATIONS

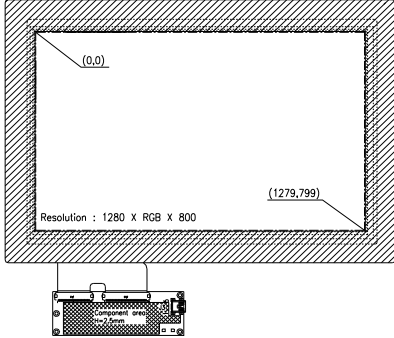
Item	Specification	Unit
Type	Transparent type projected capacitive touch panel	
Input mode	Human's finger	
Multi touch	5	Point
Interface	USB	
Report rate	122(Max)	Points/sec
Response time	15	ms
(X,Y) Position	 <p>Resolution : 1280 X RGB X 800</p>	
FW	TBD	

11.2 CTP Absolute Maximum Rating

Symbol	Description	Min	Typ	Max	Unit	Notes
VCC	Supply voltage	-0.3	-	6.5	V	USB 5V
Vio	DC input voltage	-0.3	-	VCC+0.3	V	

11.3 CTP DC Electrical Characteristic

Symbol	Description	Min	Typ	Max	Unit	Notes
VCC	Supply voltage	4.75	5	5.25	V	
GND	Supply voltage	-	0	-	V	
ICC	Supply current	-	50	-	mA	VCC=5V

11.4 CTP PIN CONNECTIONS

Pin Number	Pin Name	Description
1	VCC	Power Supply Voltage
2	D-	USB D-
3	D+	USB D+
4	NC	No connection
5	GND	Ground

12. QUALITY ASSURANCE

12.1 Test Condition

12.1.1 Temperature and Humidity(Ambient Temperature)

Temperature : $25 \pm 5^{\circ}\text{C}$

Humidity : $65 \pm 5\%$

12.1.2 Operation

Unless specified otherwise, test will be conducted under function state.

12.1.3 Container

Unless specified otherwise, vibration test will be conducted to the product itself without putting it in a container.

12.1.4 Test Frequency

In case of related to deterioration such as shock test. It will be conducted only once.

12.1.5 Test Method

Reliability Test Item & Level			Remark
No.	Test Item	Test Level	
1	High Temperature Storage Test	Ta=80°C, 240hrs	IEC68-2-2
2	Low Temperature Storage Test	Ta=-30°C, 240hrs	IEC68-2-1
3	High Temperature Operation Test	Ts=70°C, 240hrs	IEC68-2-2
4	Low Temperature Operation Test	Ta=-20°C, 240hrs	IEC68-2-1
5	High Temperature and High Humidity Operation Test	T=60°C,90%RH,240hrs	IEC68-2-3
6	Thermal cycling storage test	-30°C----25°C-----80°C ,200Cycle 30min 5min 30min	IEC68-2-14
7	vibration test	Frequency:10~55HZ Amplitude:1.5mm Sweep time:11min Test period:6Cycles for each direction of X,Y,Z	IEC68-2-6
8	Drop test	Height :60cm 1 conner,3edges,6surfaces	IEC68-2-32
9	Shock test	100G,6ms,Direction:±X±Y±Z Cycle:3times	IEC68-2-27
10	ESD test	Location: LCM/TP surface Condition:150pf 330Ω Contact +/- 4kV Air +/-8kV Criteria: Class C	IEC61000-4-2

12.2 Inspection condition

12.2.1 Inspection conditions

12.2.1.1 Inspection Distance : 35 ± 5 cm

12.2.1.2 View Angle:

(1) Inspection that light pervious to the product: $\pm 5^\circ$

(2) Inspection that light reflects on the product: $\pm 45^\circ$

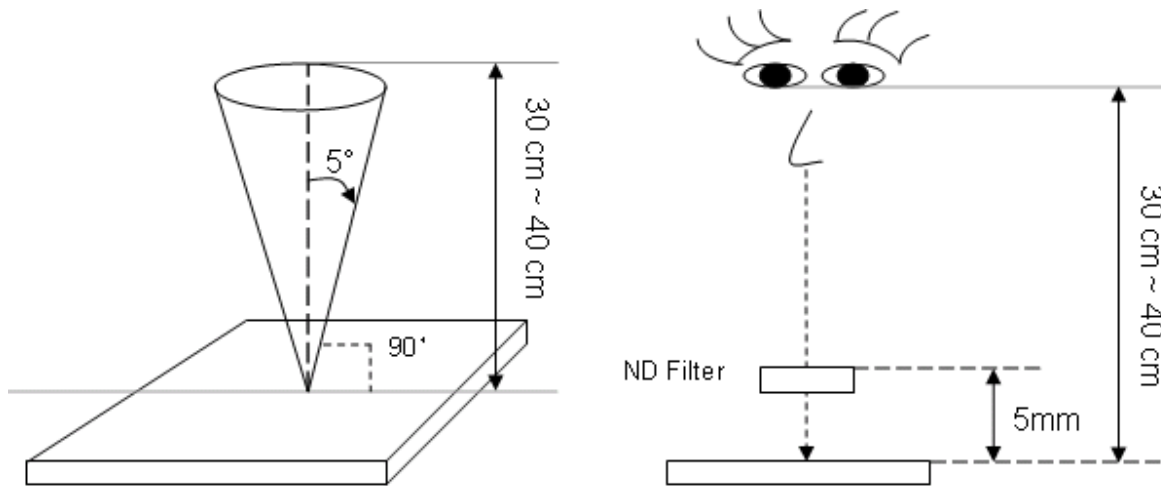

12.2.1.2 Environment conditions :

Ambient Temperature :	$25 \pm 5^\circ\text{C}$
Ambient Humidity :	30~75%RH
Ambient Illumination	600~800 lux

12.2.2 Inspection Parameters

Appearance inspection standard (D: diameter, L: length; W: width, Z: height, T: glass thickness, n: number)

Inspection item	Inspection standard	Description
No image	Prohibited	
Image abnormal	Prohibited	
Bright line	Prohibited	
Mura	It is acceptable that the defect can not be seen with 2% ND filter.	

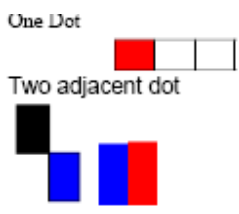
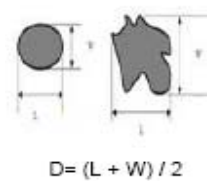
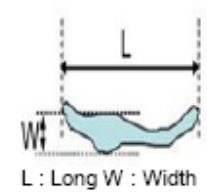
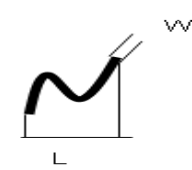
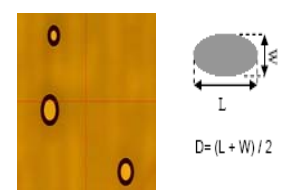
Dot	Item	Acceptable	Total	
		Visible area		
	Bright dot	3	6	
	Dark dot	5		
	Bright adjacent dots	1	1	
	Dark adjacent dots	2	2	
Adjacent dots with a bright dot and a dark dot	2	2		
Foreign material in dot shape	SPEC (unit: mm)	Acceptable		
	$D \leq 0.5$	Ignored		
	$0.5 < D \leq 0.8$, distance > 5	$n \leq 5$		
	$D > 0.8$	0		
Foreign material in line shape	SPEC (unit: mm)	Acceptable		
	$W \leq 0.05$ and $L \leq 10$	Ignored		
	$0.05 < W \leq 0.1$, $L \leq 10$, distance > 5	$n \leq 5$		
	$W > 0.1$ or $L > 10$	0		
Contamination	It is acceptable if the dirt can be wiped.			
Inspection item	Inspection standard		Description	
Scratch	SPEC (unit: mm)	Acceptable		
	$W \leq 0.05$ and $L \leq 10$	Ignored		
	$0.05 < W \leq 0.08$, $L \leq 10$, distance > 5	$n \leq 5$		
	$0.08 < W \leq 0.1$, $L \leq 10$, distance > 5	$n \leq 3$		
	$W > 0.1$ or $L > 10$	0		
Bubble	SPEC (unit: mm)	Acceptable		
	$D \leq 0.3$	Ignored		
	Non visible area	Ignored		
	$0.3 < D \leq 0.5$, distance > 5	$n \leq 5$		
	$D > 0.5$	0		
Insufficient glue	SPEC (unit: mm)	Acceptable		
	Non visible area	Ignored		
	Visible area	0		

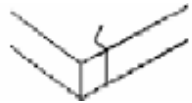
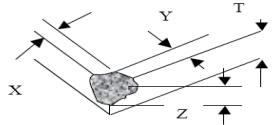
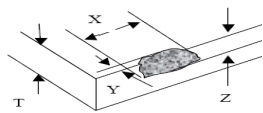
Cover & Sensor Crack	Prohibited		
Sensor angle missing & edge break	SPEC (unit: mm)	Acceptable	
	Damage circuit or effect function	0	
Cover/Sensor angle missing	SPEC (unit: mm)	Acceptable	
	$X \leq 3.0, Y \leq 3.0, Z \leq T$	Ignored	
	$X > 3.0, Y > 3.0, Z > T$	0	
Cover/Sensor edge break	SPEC (unit: mm)	Acceptable	
	$X \leq 3.0, Y \leq 3.0, Z \leq T$	Ignored	
	$X > 3.0, Y > 3.0, Z > T$	0	
Ink	SPEC (unit: mm)	Acceptable	
	word unclear, inverted, mistake, break line	0	
Bubble under protection film	SPEC (unit: mm)	Acceptable	
	NA		
Function	Prohibited		

12.3 Sampling Condition

Unless otherwise agree in written, the sampling inspection shall be applied to the incoming inspection of customer.

Lot size: Quantity of shipment lot per model.

Sampling type: normal inspection, single sampling

Sampling table: ISO 2859

Inspection level: Level II

Class of defects	Definition		
	Major	AQL 0.65	It is a defect that is likely to result in failure or to reduce materially the usability of the product for the intended function.
	Minor	AQL 1.5	It is a defect that will not result in functioning problem with deviation classified.

13. LCM PRODUCT LABEL DEFINE

Product Label style:

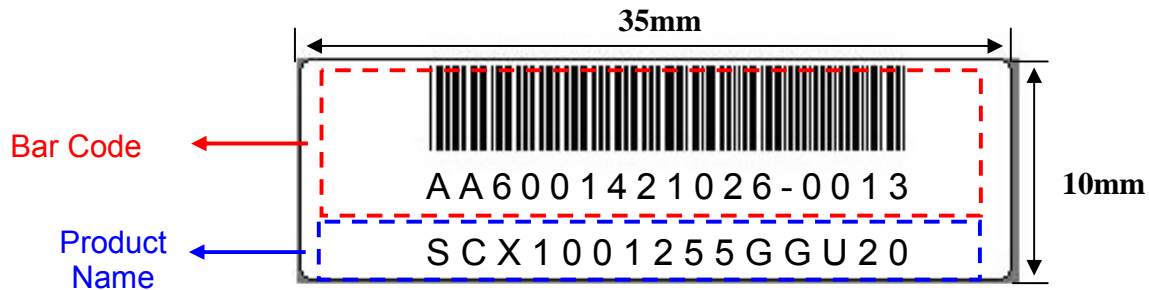

BarCode Define:

A A 6 0014 2 10 26-0013

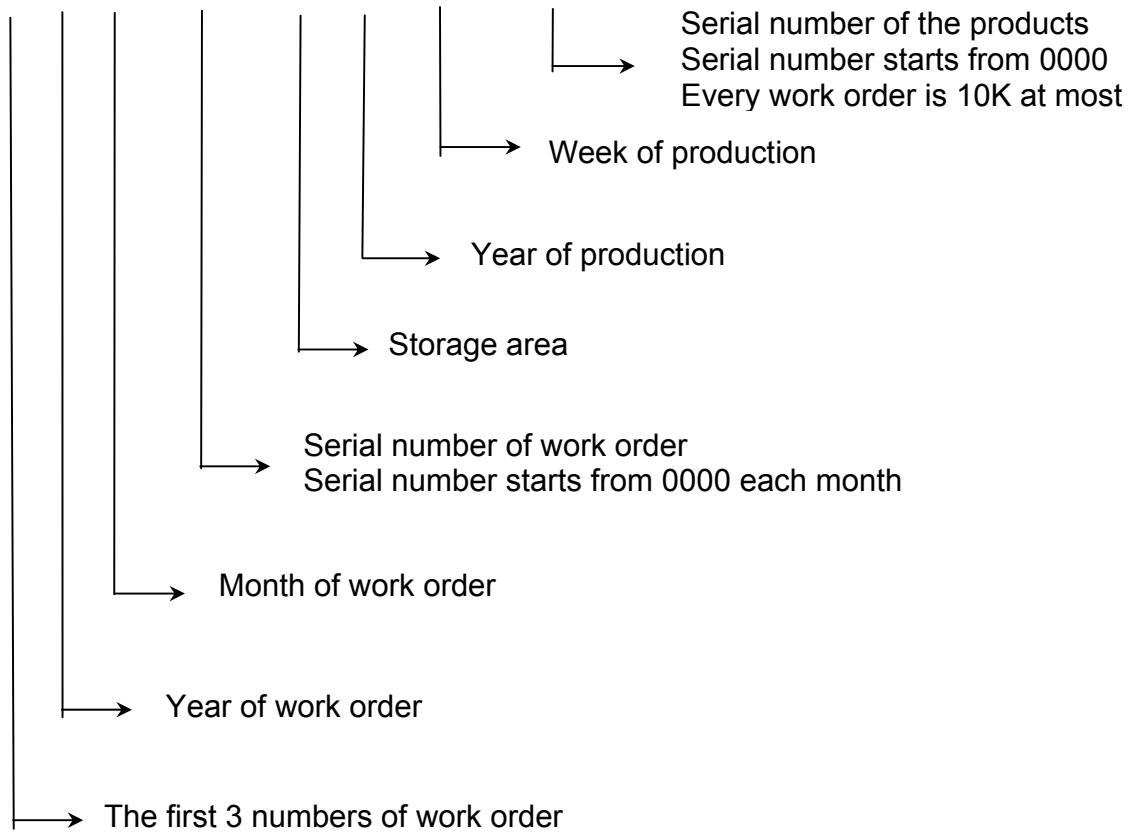

Product Name Define:

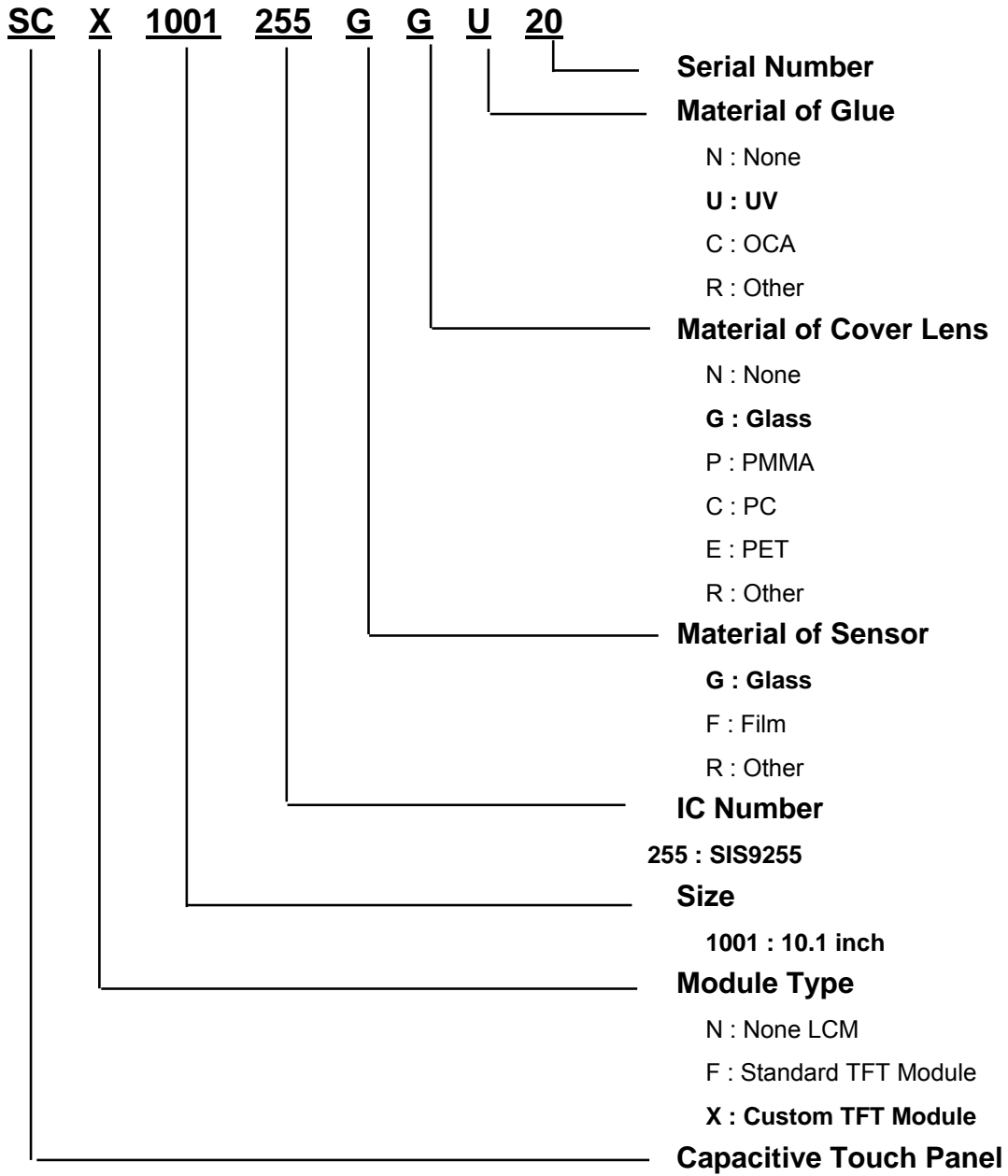

14. PRECAUTIONS IN USE LCM

1. ASSEMBLY PRECAUTIONS

- (1) You must mount a module using holes arranged in four corners or four sides.
- (2) You should consider the mounting structure so that uneven force (ex. Twisted stress) is not applied to the module. And the case on which a module is mounted should have sufficient strength so that external force is not transmitted directly to the module.
- (3) Do not touch, push or rub the exposed polarizers with glass, tweezers or anything harder than HB pencil lead. And please do not rub with dust clothes with chemical treatment.
- (4) Wipe off saliva or water drops as soon as possible. Their long time contact with polarizer causes deformations and color fading.
- (5) Do not open the case because inside circuits do not have sufficient strength.
- (6) Please do not take a LCD module to pieces and reconstruct it. Resolving and reconstructing modules may cause them not to work well.
- (7) Please do not touch metal frames with bare hands and soiled gloves. A color change of the metal frames can happen during a long preservation of soiled LCD modules.
- (8) Please pay attention to handling lead wire of backlight so that it is not tugged in connecting with inverter.

2. OPERATING PRECAUTIONS

- (1) Please be sure to turn off the power supply before connecting and disconnecting signal input cable.
- (2) Please do not change variable resistance settings in LCD module. They are adjusted to the most suitable value. If they are changed, it might happen LCD does not satisfy the characteristics specification
- (3) Be careful for condensation at sudden temperature change. Condensation makes damage to polarizer or electrical contacted parts. And after fading condensation, smear or spot will occur.
- (4) When fixed patterns are displayed for a long time, remnant image is likely to occur.
- (5) Module has high frequency circuits. Sufficient suppression to the electromagnetic interference shall be done by system manufacturers. Grounding and shielding methods may be important to minimize the interference.
- (6) Please consider that LCD backlight takes longer time to become stable of radiation characteristics in low temperature than in room temperature.

3. ELECTROSTATIC DISCHARGE CONTROL

- (1) The operator should be grounded whenever he/she comes into contact with the module. Never touch any of the conductive parts such the copper leads on the PCB and the interface terminals with any parts of the human body.

- (2) The modules should be kept in antistatic bags or other containers resistant to static for storage.
- (3) Only properly grounded soldering irons should be used.
- (4) If an electric screwdriver is used, it should be well grounded and shielded from commutator sparks.
- (5) The normal static prevention measures should be observed for work clothes and working benches; for the latter conductive (rubber) mat is recommended
- (6) Since dry air is inductive to statics, a relative humidity of 50-60% is recommended.

4. STORAGE PRECAUTIONS

- (1) When you store LCDs for a long time, it is recommended to keep the temperature between 0°C-40°C without the exposure of sunlight and to keep the humidity less than 90%RH.
- (2) Please do not leave the LCDs in the environment of high humidity and high temperature such as 60°C 90%RH
- (3) Please do not leave the LCDs in the environment of low temperature; below -20°C.

5. OTHERS

- (1) A strong incident light into LCD panel might cause display characteristics' changing inferior because of polarizer film, color filter, and other materials becoming inferior. Please do not expose LCD module direct sunlight and strong UV rays
- (2) Please pay attention to a panel side of LCD module not to contact with other materials in preserving it alone.
- (3) For the packaging box, please pay attention to the followings:
 - a. Please do not pile them up more than 5 boxes. (They are not designed so.) And please do not turn over.
 - b. Please handle packaging box with care not to give them sudden shock and vibrations. And also please do not throw them up.
 - c. Packing box and inner case for LCDs are made of cardboard. So please pay attention not to get them wet. (Such like keeping them in high humidity or wet place can occur getting them wet.)
- (4) Waste
Liquid crystal module products shall not be arbitrarily discarded, the water and soil have a negative impact on the environment, the need to be handled by a qualified unit.

6. LIMITED WARRANTY

Unless otherwise agreed between DATA IMAGE and customer, DATA IMAGE will replace or repair any of its LCD and LCM which is found to be defective electrically and visually when inspected in accordance with DATA IMAGE acceptance standards, for a period on one year from date of shipment. Confirmation of such date shall be based on freight documents. The warranty liability of DATA IMAGE is limited to repair and/or replacement on the terms set forth above. DATA IMAGE will not responsible for any subsequent or consequential events.

15. OUTLINE DRAWING

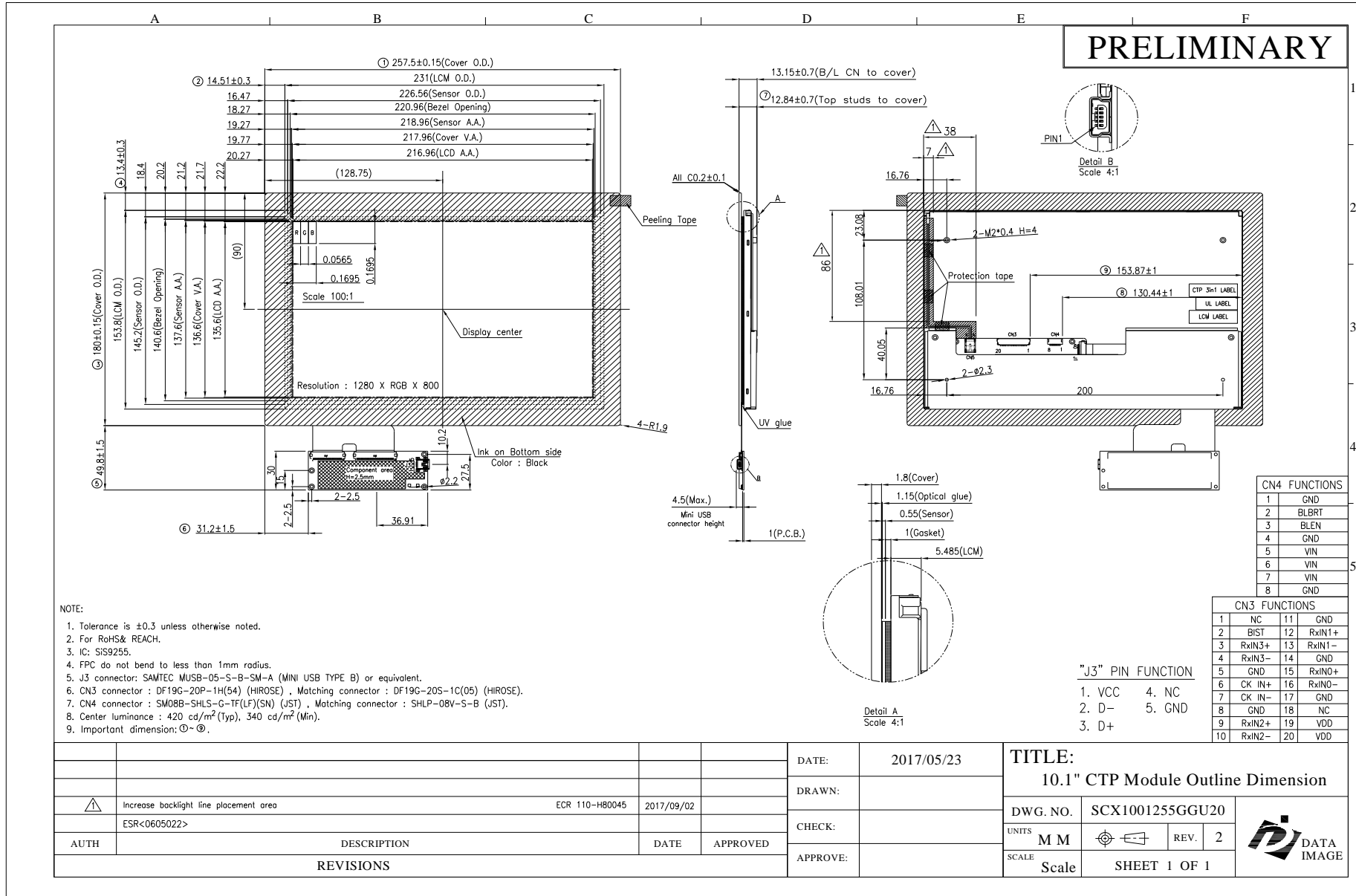



16. PACKAGE INFORMATION

TBD